

Article number: 201241467

Description: E+G Retaining magnets with threaded stud GN 52.4-AN-50-M10-E  
Alu, Nickel, Cobalt - 450° C, 400N

## Measures

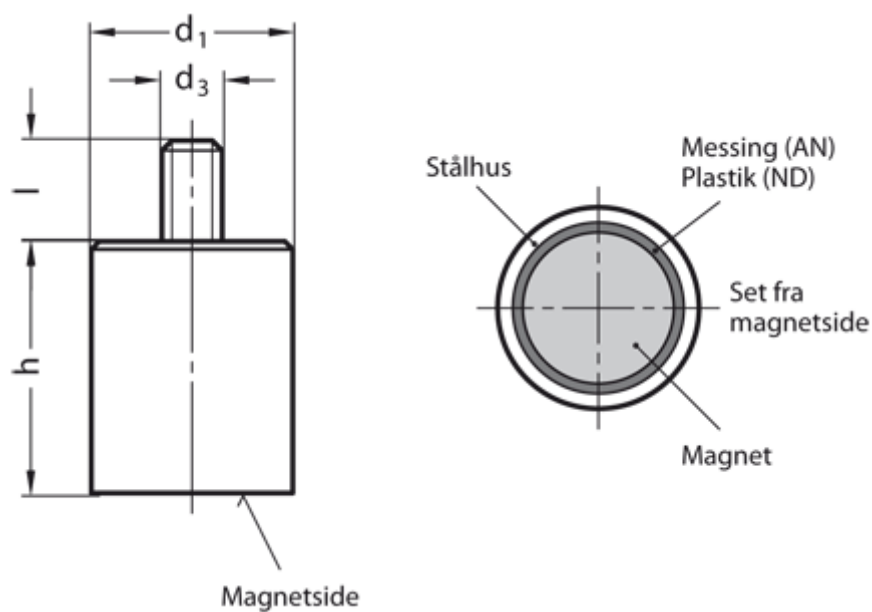

d1	= 50
d3	= M10
h	= 60 ±0,2
Holding force N	= 400.0
l	= 15
Material	= AN Alu, nickel, cobalt, 450°C